







13 672 780



- 280mm projection
- cascade
- total height 830 - 900 mm
- height up to aerator 665 – 735 mm
- push-on rosette 130 x 130 mm
- max. flow 47.8 l/min at 3 bar flow pressure

	Dark Chrome	13 672 780-19
	Chrome	13 672 780-00
	Brushed Platinum	13 672 780-06
	Platinum	13 672 780-08
	Brushed Durabronze (23kt Gold)	13 672 780-28
	Brushed Champagne (22kt Gold)	13 672 780-46
	Champagne (22kt Gold)	13 672 780-47

13 672 780

mm [inches]

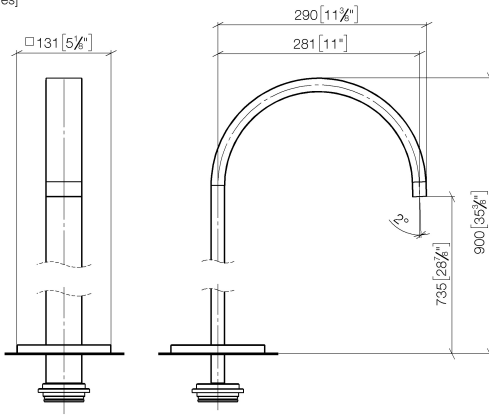

Flow rate chart



Codes & Standards

ASME
A112.18.1/CSA
B125.1

13 672 780

Parts for other
finishes can be found
here: [Chrome](#)

